

HTM **SERIES**



FULL-RANGE CLASS-D AMPLIFIERS

Product Manual





Thank you for choosing Wet Sounds™ products!

Wet Sounds' products are designed and crafted to achieve or exceed the highest performance standards in the industry. Wet Sounds HTM Series Amplifiers are designed to be a complete solution for every type of extreme application. HTM amplifiers use superior performance circuitry by utilizing Class-D Power Supplies. These amplifiers have extreme power output packed inside a small chassis, thermal overload protection, flexible crossovers, & extended inputs. We build every amplifier with unsurpassed passion as well, so we can deliver the highest performing products to you. We live and breathe high performance audio so you can enjoy the very best audio experience wherever you go.

Please take a moment to read the instruction manual before starting your installation. This guide will explain the benefits of the technologies developed by Wet Sounds and will help you understand the correct installation methods and use of this product. If you have any questions or concerns, please contact a certified Wet Sounds dealer. You may also contact Wet Sounds technical support by dialing 1-877-WET-SPKR (1-877-938-7757).

!WARNING!

We build all Wet Sounds products to play at high volumes for extended periods of time. Your ears however are not designed for high volume listening. This product can easily generate high volumes that can permanently damage your hearing. We urge you to limit your exposure to very high volume sound. You may also find your state laws governing the volume of an audio system. Please be aware of all local and state laws in your area. A properly tuned and operated audio system will deliver years of enjoyment when used properly.

TABLE OF CONTENTS

Please take a moment to look over this instruction manual before enjoying the product.

Product Dimensions	4
Technical Specifications	5
Product Features	6-7
Amplifier Setup	8
Sample Setup	9-12
Troubleshooting	13
Limited Warranty	14

PRODUCT DIMENSIONS

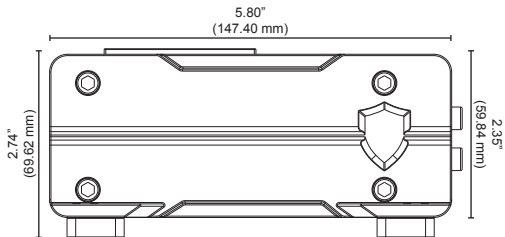
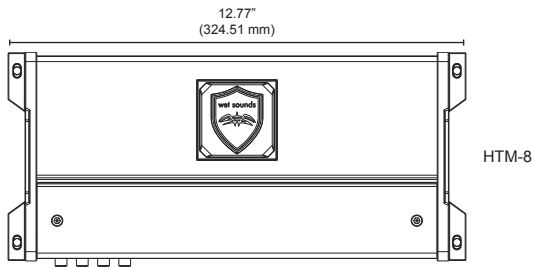
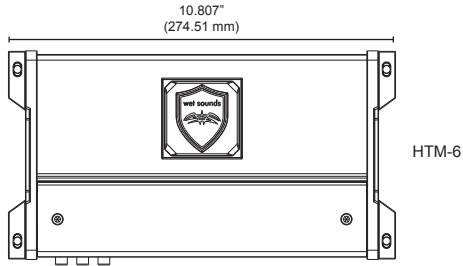
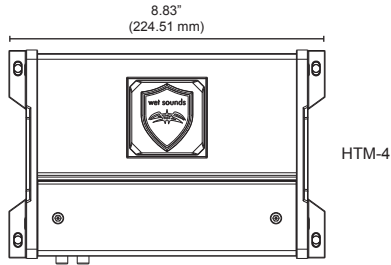
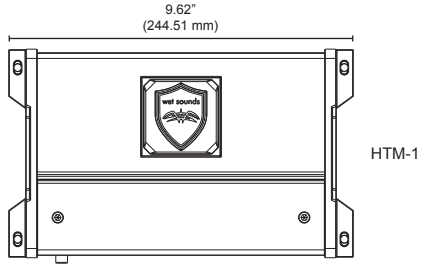

* Side Profile Shared
Dimensions

WHAT'S INCLUDED

- (1) HTM Series Amplifier
- (4) Mounting Feet / Spacers
- (1) Logo Badge

TECHNICAL SPECIFICATIONS

Tech Spec.	HTM-1	HTM-4	HTM-6	HTM-8
Amp Channels	1	4	6	8
Stereo @ 4 Ohms	500W x 1 (Mono)	85W x 4	85W x 6	85W x 8
Stereo @ 2 Ohms	800W x 1 (Mono)	150W x 4	150W x 6	150W x 8
Bridged @ 4 Ohms	X	300W x 2	300W x 3	300W x 4
Bridged @ 1 Ohm	1200W x 1 (Mono)	X	X	X
Selectable Crossover	Full / HP / LP	Full / HP / LP	Full / HP / LP	Full / HP / LP
Crossover Range	50 Hz - 500 Hz	50 Hz - 500 Hz	50 Hz - 500 Hz	50 Hz - 500 Hz
S/N (Awtg)	105 dB	95 dB	95 dB	95 dB
Freq. Response -3 dB	20 Hz - 20 kHz	20 Hz - 20 kHz	20 Hz - 20 kHz	20 Hz - 20 kHz
Input Sensitivity (gain)	350 mVrms - 6 Vrms	350 mVrms - 6 Vrms	350 mVrms - 6 Vrms	350 mVrms - 6 Vrms
SubSonic	10 Hz - 55 Hz	10 Hz - 55 Hz (CH 3/4)	10 Hz - 55 Hz (CH 5/6)	10 Hz - 55 Hz (CH 7/8)

PRODUCT FEATURES

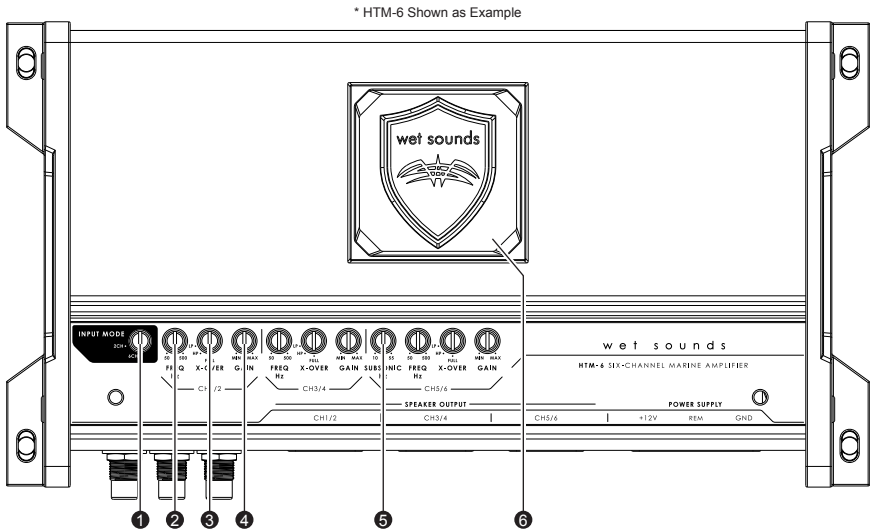

1. Input Mode - Adjusting this switch to 2CH input and connecting only the CH 1/2 inputs allows the amplifier to output to all channels.

2. Variable Crossover - Built-in crossover with frequency range of 50 Hz - 500 Hz

3. X-Over Switch - Allows switching of the frequency between Full/HP/LP for the channels

High-Pass - Designed to play only the frequencies above where the x-over is set at. Recommended to set at 80 Hz & up for coaxial & tower speakers.

Low-Pass - Designed to play only the frequencies below where the x-over is set at. Recommended to set at 80 Hz & below for all subwoofer applications.

Full-Range - This turns off the x-over and allows the amplifier to play every frequency. * Not used in most applications.

4. Gain Control - Adjusts the input sensitivity for the CH

5. Sub-Sonic Filter - This control is variable from 10 Hz - 55 Hz and acts like a x-over but at very low frequencies. It will remove frequencies lower than the speaker/enclosure can reproduce, which can be very hard on a woofer and/or amplifier.

6. Backlit LED System Badge - Will illuminate Blue when powered on, will illuminate Red if the amplifier is in protection, letting you know there is an issue.

PRODUCT FEATURES

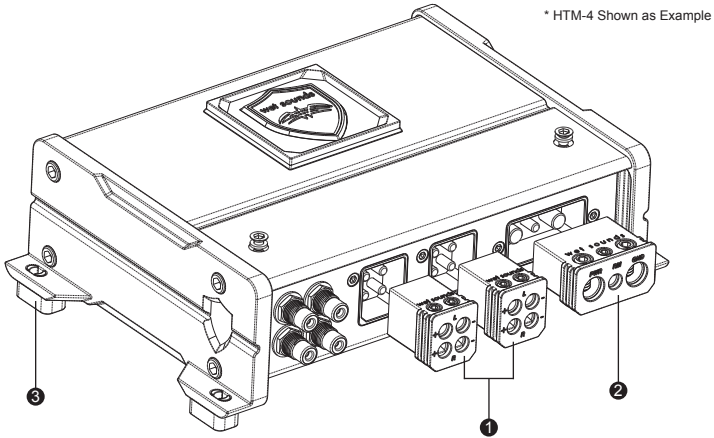

- 1. Removeable Speaker Plugs** - Helps reduce signal loss by maintaining a consistent and low-resistance connection. This is especially important for high-quality audio systems where signal integrity is crucial for optimal sound reproduction and minimizing the risk of short circuits by preventing exposed wire ends from coming into contact with other wires or metal surfaces, also creating a neater installation.
- 2. Removeable Power Plug** - During the initial installation of a system, the removable connectors help simplify the wiring process. Wiring can be connected and disconnected without the need for extensive re-wiring, saving time and reducing the likelihood of errors.
- 3. Removeable Mounting Spacers** - Designed to give easy access to run wiring under the amplifier by raising the amplifier off the mounting surface to allow a cleaner installation and allowing more air circulation around the amplifier.

AMPLIFIER SETUP

Input Selection

Because of the wide range of head unit/radio output configurations all Wet Sounds amplifiers have an adjustable input sensitivity or "GAIN". The gain is NOT a volume or a power limiting control similar to a throttle. It makes the amplifier more sensitive to input from the stereo. When the gain is turned up the amplifier will reach full output at lower volume levels on the head unit/radio. Also when the gain is set too high the amplifier becomes much more sensitive to noise from your electrical system.

Adjusting the Gain

You will need a small flat head screwdriver and select the style/genre of music you primarily enjoy listening to.

Here are 3 easy steps to follow:

1. Turn the gain all the way counter clockwise to the "min" point on the amp.
2. Increase the head unit/radio volume to $\frac{3}{4}$ of the maximum volume output while paying your favorite style/genre of music.
3. Gently turn the gain clockwise to increase the amplifiers output until the desired level of output is achieved.

****You will repeat these steps for both the front and rear channels independently****



You should not hear any distortion in your speakers at this level, if you do, slowly turn down the gain until distortion is no longer present. If you need further assistance please contact Wet Sounds Technical Services Department.

Crossover Controls

HTM amplifiers are designed to play frequencies between 50 Hz - 500 Hz. The amplifier is equipped with 3 different optional settings. High-Pass (HP), Low-Pass (LP), and Full-Range (FULL).

High-Pass - Designed to play only the frequencies above where the x-over is set at. Recommended to set at 80 Hz & up for coaxial & tower speakers.

Low-Pass - Designed to play only the frequencies below where the x-over is set at. Recommended to set at 80 Hz & below for all subwoofer applications.

Full-Range - This turns off the x-over and allows the amplifier to play every frequency. * Not used in most applications.

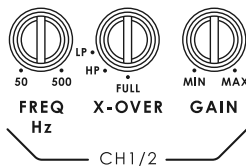

SAMPLE SETUP

HTM-1 Examples

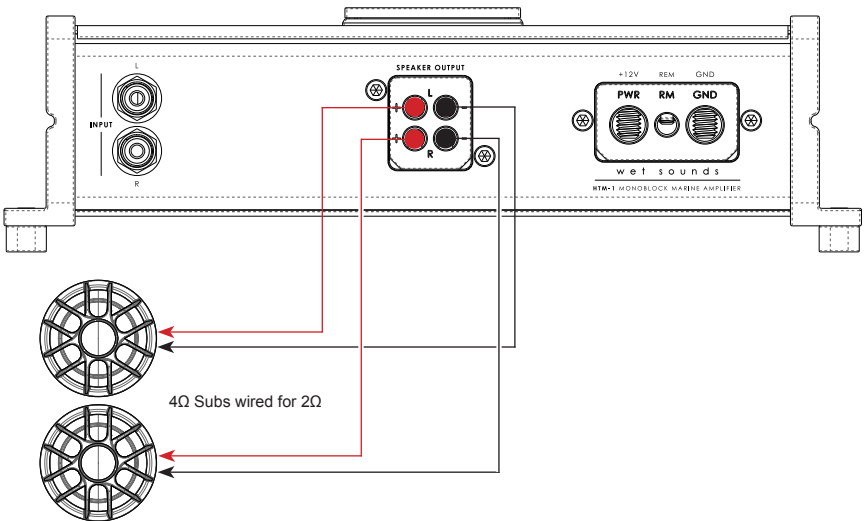
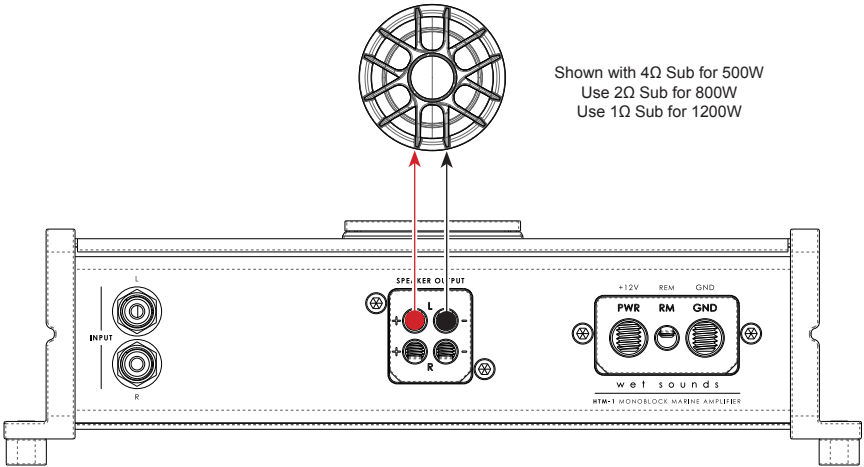

SAMPLE SETUP

HTM-4 Examples

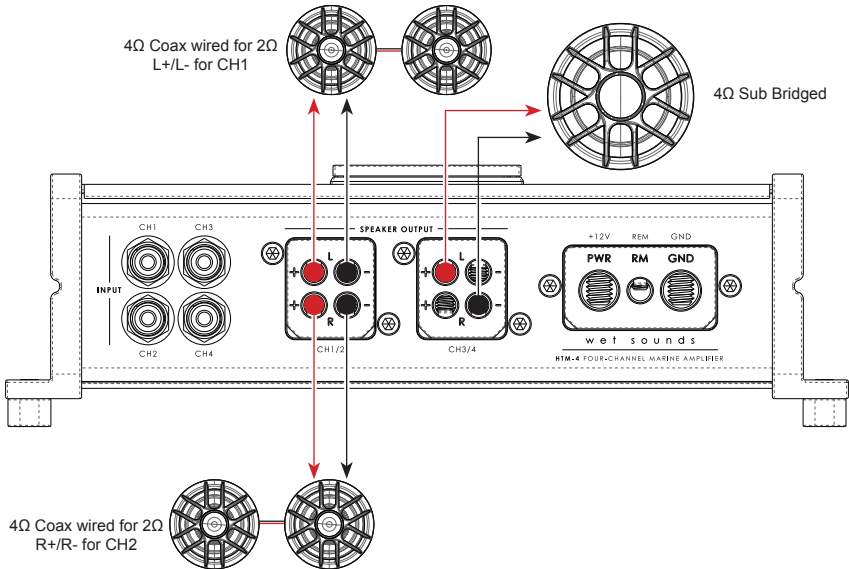
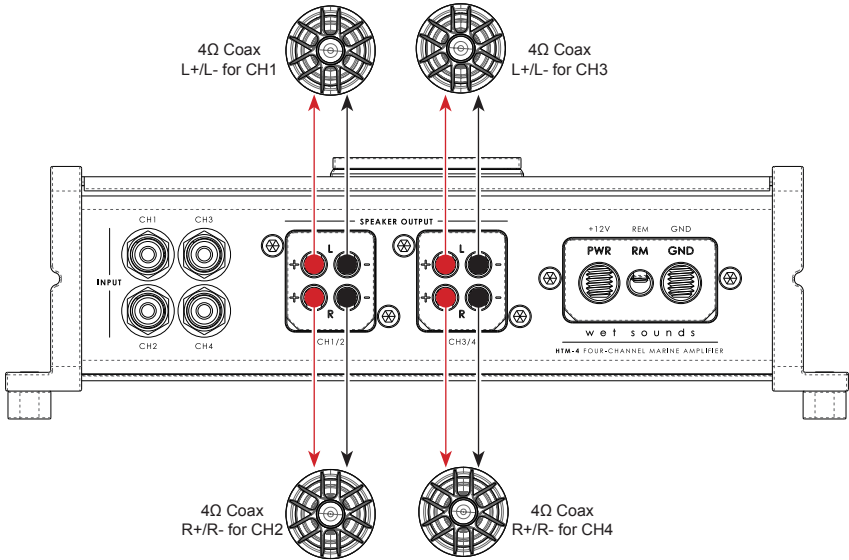

SAMPLE SETUP

HTM-6 Examples

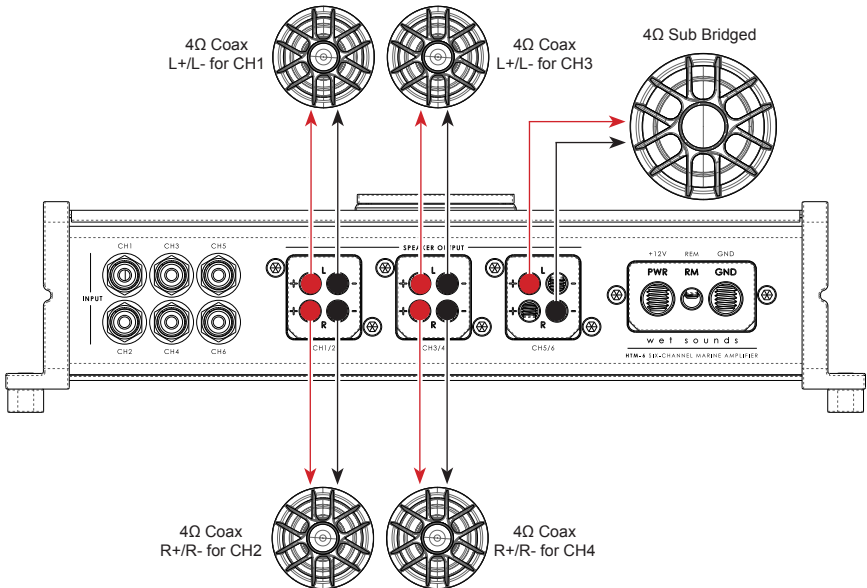
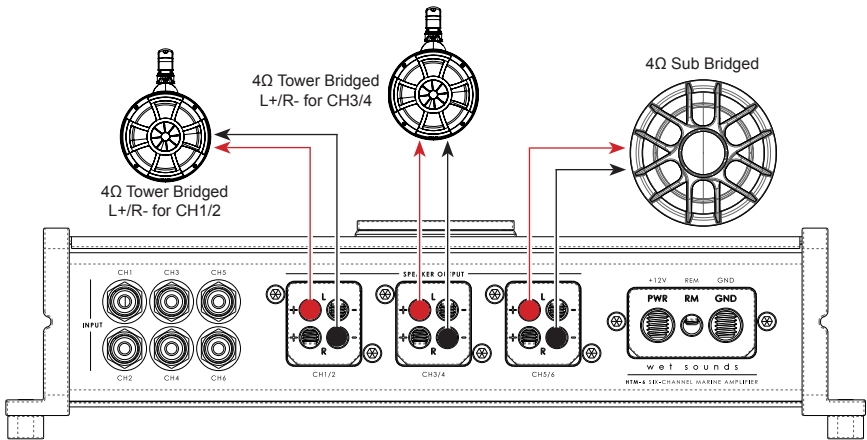

SAMPLE SETUP

HTM-8 Examples

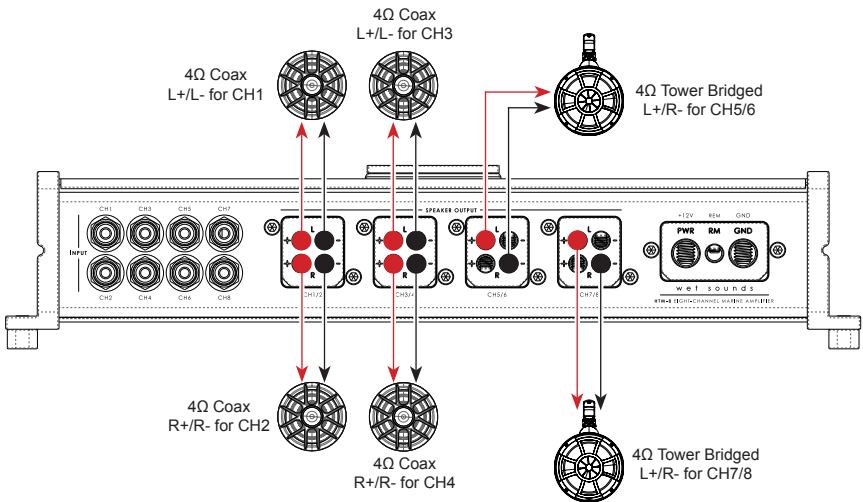
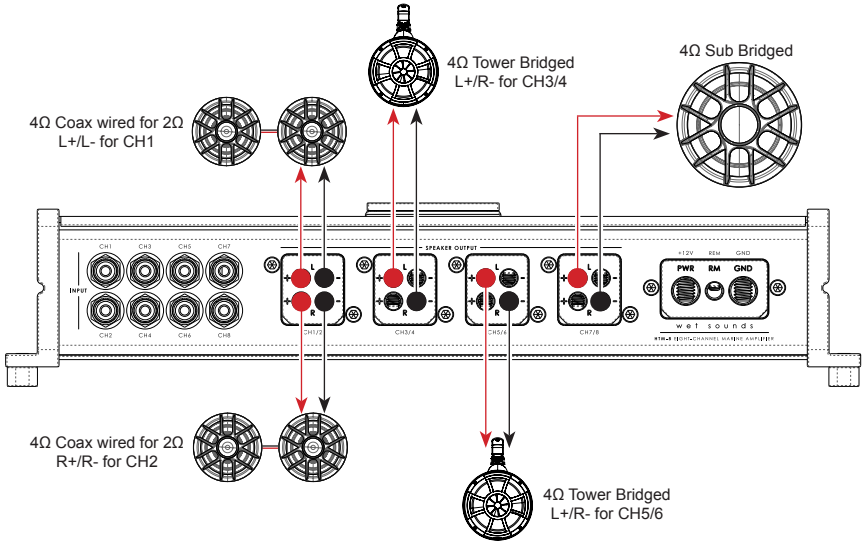

TROUBLESHOOTING

The Laws of Nature

Your amplifier does NOT make power; it converts power, or current, from your electrical system and converts it into high power musical energy. If the amp can't get all the power it needs it will not produce its full output. Your Wet Sounds amplifier will produce full output longer than other amplifiers on the market today. Should your voltage or current drop too low the amplifier will drop below the rated output.

Make sure your boats charging system is in good working order. Any high performance audio amplifier will increase the demand on your alternator and battery. If you are unsure, have your charging system checked by a professional technician.

RUNNING THE WIRE CABLES

****Always keep the signal cable and the power cables separated to prevent the possibility of inducing noise into the system****

Carefully run the power and the signal cables through your application. Always keep all the wires tight and tied down to prevent the power wire from shorting and reduce the risk of fire. A 4 AWG or larger wire should be used for power and ground connections. We recommend a fuse to be installed on the power wire within 18 inches of the battery for safety.

Max Fuse Size

HTM-1: 125a

HTM-4: 50a

HTM-6: 75a

HTM-8: 100a



If you are experiencing problems with your amplifier after installation, follow these procedures to try and remedy the problem.

1. Check your main power fuse and replace if necessary.
2. Confirm your Ground wire has a good connection.
3. Make sure your remote wire and power wire has +12 Volts.
4. Make sure your battery has 12 volts.
5. Confirm that the amplifier LED color is blue. If the light flashing is red than the amplifier is in protection mode. If the light is red check the following items below:
 - A. Confirm that speaker is in working order.
 - B. Confirm that there are no loose wires that could be grounding out the amplifier or speaker(s).
 - C. Check that the amplifier has sufficient air circulation where it is located. Insufficient air flow and overdriving the audio system could result in the amplifier going into protection to preserve the amplifier.

If you have followed these steps and are still experiencing issues, you can contact our Service Department either by phone at 877-938-7757 or by email at warranty@wetsounds.com. Please see the Limited Warranty on the next page.

LIMITED WARRANTY

What This Warranty Covers

This is a "Limited" warranty. This warranty covers any defects in materials and workmanship and the warranty only applies to the original purchaser and is not transferable. This warranty is only valid if the original purchase was made from an authorized Wet Sounds dealer.

How Long Coverage Lasts

This warranty runs for 2 years from the date of the purchase.

What Is Not Covered

This warranty does not cover fading or discoloration caused by exposure to sunlight or chemicals such as ammonia, household bleach, or any cleaning material that contains abrasive substances. For information on how to prevent fading or discoloration, consult recommendations on cleaning products. Wet Sounds, Inc. does not cover the cost for removal and reinstallation of any kind. Additionally, shipping to Wet Sounds, Inc. is covered by the purchaser. This warranty is void and inapplicable if Wet Sounds deems that the product was abused or misused; including but not limited to Speaker product that has been improperly-powered (under or over powered), causing thermal (burnt voice coil) and/or mechanical failure (torn surrounds or spiders), damage caused by accident, mishandling, improper installation, negligence, normal wear and tear, excessive water or heat damage, freight damage or products that have been altered in any way. (The warranty is not transferable and will neither apply to products purchased from unauthorized dealers nor product owned by anyone other than the original purchaser from an authorized Wet Sounds dealer.) Wet Sounds is not responsible for any damages to a consumer's boat or person from a product failure. The warranty is void if Wet Sounds deems the product was installed or used improperly. Wet Sounds shall not be responsible for any incidental or consequential damages, except to the extent provided (or prohibited) by applicable law.

What Wet Sounds, Inc. Will Do

Wet Sounds, Inc will repair any part of your product that proves to be defective in materials or workmanship. In the event repair is not possible, Wet Sounds, Inc. will replace the product in question. If it is deemed necessary, Wet Sounds, Inc. will either replace the entire product with a refurbished unit or it will be replaced with a model that is similar in price if that model is no longer available. Labor cost and materials needed to complete this service will be at no charge to the purchaser. Additionally, the cost of shipping to the consumer is also covered under this warranty.

How to Obtain Warranty Service

Contact Wet Sounds, Inc. either by phone at 877-938-7757 or by email at warranty@wetsounds.com. A service representative will assist you in the necessary actions to verify that the problem that you are experiencing is covered under warranty. If it is in fact a warranty issue, Wet Sounds will issue an RMA number for tracking purposes and give instructions on sending the product in for evaluation.

How State Law Applies

This warranty gives you specific legal rights, and you may also have other rights which vary from state to state.

Internet Warning

Wet Sounds, Inc. products sold on any unauthorized website or internet auction site are void of any and all manufacturer's warranty. Please contact Wet Sounds at 877-938-7757 or visit our website at www.wetsounds.com to search for an authorized site and/or an authorized retailer near you.

Caution & Respect

Wet Sounds speakers can achieve very high sound pressure levels. Please use this product responsibly. Be aware that sound travels great distances across water so please respect other boaters especially while loading/unloading at the ramp or dock. Wet Sounds, Inc. is not responsible for any violations of the law that may be a direct result of excessive volume. Please abide by the rules but have fun doing it.



HTM AMPLIFIERS



PROUDLY
DESIGNED
IN THE
USA

Wet Sounds, Inc.
www.wetsounds.com
877-938-7757

2975 Louise Street
Rosenberg, Texas 77471 USA

© 2024 Wet Sounds, Inc. All Rights Reserved. WET SOUNDS and associated logos where applicable are registered trademarks of Wet Sounds Corporation in the United States and/or other countries. All other trademarks are the property of their respective owners.