

***SYN-DX* SERIES**

FULL RANGE CLASS-D AMPLIFIERS

SYN-DX 2, SYN-DX 2.3 HP, SYN-DX 4, SYN-DX 6
OWNER'S MANUAL



wetsounds.com

CONGRATULATIONS!

Thank you for purchasing the Wet Sounds SYN-DX series amplifier. Wet Sounds represents the ultimate in High Performance Marine Audio. Wet Sounds SYN-DX Series Marine Amplifiers are designed to be a complete solution for every type of extreme marine application. SYN-DX amplifiers use superior performance circuitry by utilizing Class D Power Supplies. These amplifiers have extreme power output packed inside a small chassis, thermal overload protection, flexible crossovers, extended inputs. SYN-DX amplifiers are a well balanced match for all of the Wet Sounds™ products.

⚠ WARNING ⚠

We build all Wet Sounds products to play at high volumes for extended periods of time. Your ears however are not designed for high volume listening. This product can easily generate high volumes that can permanently damage your hearing. We urge you to limit your exposure to very high volume sound. You may also find your state has laws governing the volume of an audio system. **Please be aware of all local and state laws in your area. A Properly tuned and operated audio system will deliver years of enjoyment when used properly.**

⚠ WARNING ⚠

Please check the installation location before you begin. Do not cut any of the boats structure. Pay close attention to what items are behind the panels and carpet. Often the manufacturer will hide wires, mechanical or other electronic devices in the exact locations you wish to install in.



WET SOUNDS SYN-DX SERIES AMPLIFIERS

INSTALLATION INSTRUCTIONS

Wet Sounds Marine Amplifiers are designed for easy installation in your boat. To ensure proper installation of your new purchase please follow all the suggestions listed below. **If you do not have experience with marine electrical and mechanical systems contact a professional installer. Paying a qualified installer is almost always cheaper than paying a dealership to repair your boat.**

LOCATING THE AMPLIFIER

The amplifier must be securely mounted to a solid surface. Please select a dry location to mount your amplifier. All Wet Sounds products are designed to operate in humid environments however direct contact with water can damage the electronics. Do not mount the amplifier to any area that may have excessive vibration (like a subwoofer enclosure). Position the amplifier in an area that receives sufficient airflow for proper heat dissipation.

SUPPLYING ENOUGH POWER

Your amplifier does NOT make power; it converts power, or current, from your boats electrical system and converts it into high power musical energy. If the amp can't get all the power it needs it will not produce its full output. Your Wet Sounds amplifier will produce full output longer than other amplifiers on the market today. Should your voltage or current drop too low the amplifier will drop below the rated output. Make sure your boats charging system is in good working order. Any high performance audio amplifier will increase the demand on your alternator and battery. If you are unsure have you charging system checked system testing by a professional technician.



RUNNING THE WIRING CABLES

****Always keep the signal cable and the power cables separated to prevent the possibility of inducing noise into the system****

Carefully run the power and the signal cables through the boat. Always keep all the wire tight and tied down to prevent the power wire from shorting and reduce the risk of fire. A 4 AWG or larger wire should be used for power and ground connections. We recommend a fuse to be installed on the power wire within 18 inches of the battery for safety.

AMPLIFIER CONNECTIONS

****Make sure that the +12 volt cable is NOT connected to the battery while making any of the connections until all the connections and the fuse are installed****

Power Connections

The **SYN-DX Series** is designed for **4 AWG** Power wire (+12 V) and Ground wire (GND). You will need to prepare the wire by remove 5/8" on the protective shielding on the power and ground wire. Then take a Phillips head screwdriver and back out the screws on the terminal block. Insert the +12 volt wire into the +12V side of the terminal block and then tighten the screw back into the terminal block. You will do the same for the Ground wire. See below

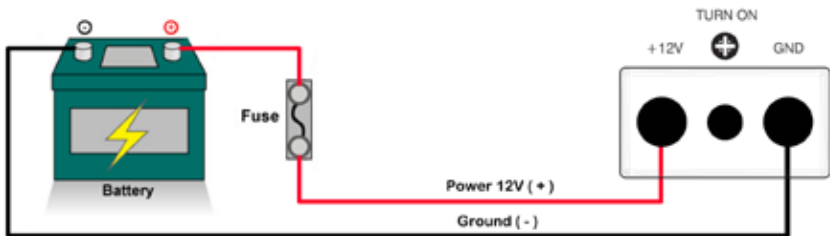

REMOTE CONNECTION

This amplifier is designed to accept a 12 AWG – 16 AWG wire input on the terminal block for speaker outputs 1 and 2. (Diagram A). The Remote Turn-on is how the amplifier knows when to turn on and off. This is typically connected to the remote output wire on an aftermarket radio. When connecting this amplifier to a factory radio, you will need to find a +12 volt accessory wire that switches on and off with the key.



AMPLIFIER SIGNAL INPUTS

Connect the RCA outputs from the source unit into the inputs of the amplifier. The SYN-DX Series has 1 pair of inputs for each pair of channels.

SYN-DX 2



SYN-DX 4

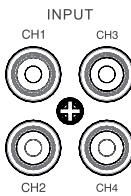

SYN-DX 6

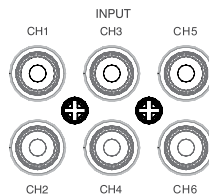

On the SYN-DX 4, there is 1 input selection switch. The switch is used to designate 2 or 4 channel input. You can select **FROM CH 1-2** when only using 1 set of RCA inputs to allow all 4 channels to have output from 1 set of RCAs (CH 1,2,3, & 4). You can select **FROM CH 3-4** to use both sets of inputs.

On the SYN-DX 6, there are 2 different input selection switches. The first is to designate 2 or 4 channel input. You can select **FROM CH 1-2** when only using 1 set of RCA inputs to allow all 4 channels to have output from 1 set of RCAs (CH 1,2,3, & 4). The next is to turn on or off the inputs for channels 5 & 6. (See below) Ch 5 & 6 can be carried over from inputs 1 & 2 when you select **FROM CH 1-2**, or a separate set of RCA cables can be used when you select **FROM CH 5-6**.

****NOTE if you only use the amplifier in 2 channel input mode you will not have fading capabilities between front and rear outputs.****

SYN-DX 4

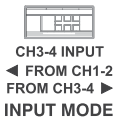

SYN-DX 6

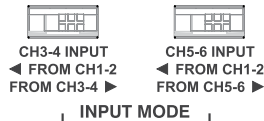

SYN-DX 2 ADVANCED SUBWOOFER CONTROLS

The SYN-DX 2-Channel Amplifier is equipped with additional features / controls when using a subwoofer on this amplifier. There is **BASS BOOST** and **SUBSONIC FILTER**. For any assistance in setting this up, please contact Wet Sounds Technical Support at 877-938-7757.

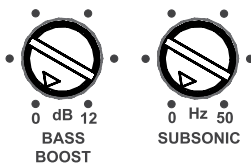

SPEAKER TERMINAL INPUTS

The SYN-DX Series utilizes removable speaker terminal blocks for easier installations and stronger power connections. The terminal blocks are designed to accept 12 AWG- 16 AWG speaker wire. When preparing the wire you will need to strip 5/8" of the cables protective shielding. Then take a small Phillips or flat head screwdriver and back out the screw on the terminal block. Insert the speaker wire into the terminal block and then tighten the screw back into the terminal block. (DO NOT OVERTIGHTEN) (See below)

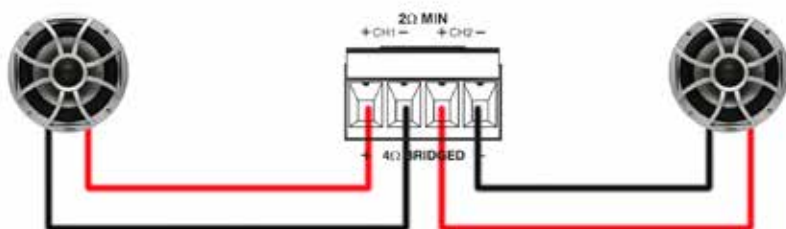

POWER INDICATOR

The amplifier is equipped with a dual illumination LED on the top of the amplifier that the Wet Sounds logo badge is mounted on. This amplifier is equipped with an advanced diagnostic system controlled by a microprocessor. In the event that the unit goes into protection for any reason it will flash a diagnostic code. The different sequences indicate the "Code" for faster trouble shooting. When the amplifier first turns on the LED will flash blue. Once the amplifier is ready for use the LED light will change to solid blue. If the amplifier is in protection mode (over voltage, under voltage, DC offset, thermal heating or speaker short) the LED light will flash a red diagnostic sequence. **See troubleshooting section for further detail.**



AMP DIAGRAM WITH LEGEND

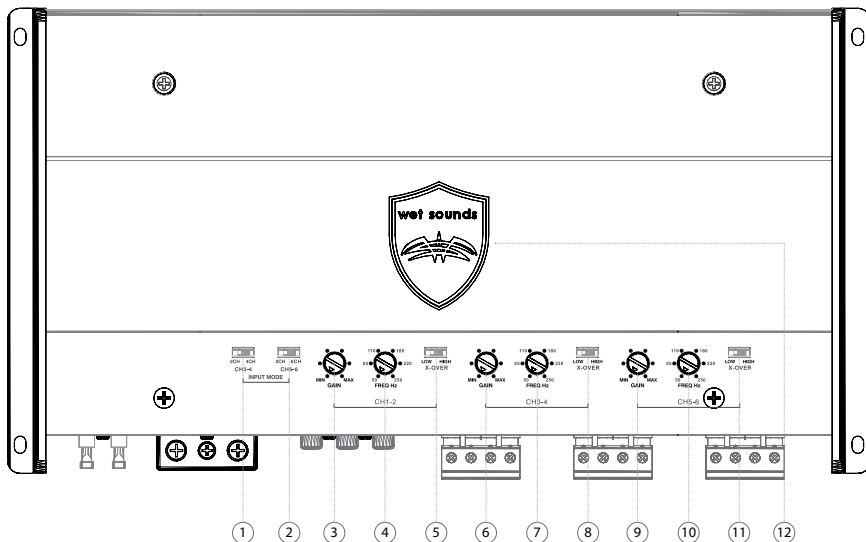

1. **Channel 3-4 Input Switch** – Adjusting this switch to 2 channel input and connecting only the CH 1/2 inputs allows the amplifier to have 4 channel output.
2. **Channel 5-6 Input Switch** – Adjusting this switch turns on/off the RCA inputs for channels 5 & 6.
3. **Gain Control 1-2** - This is the input sensitivity gain control for channels 1 & 2.
4. **Crossover Switch 1-2** - The HPF attenuates low frequencies and is used with mid-range speakers and tweeters. LPF attenuates high frequencies and is used for subwoofers. This controls channels 1 & 2
5. **Variable Crossover 1-2** – Built in 12db crossover with frequencies between 50Hz – 250Hz.
6. **Gain Control 3-4** – This is the input sensitivity gain control for channels 3 & 4.
7. **Crossover Switch 3-4** - The HPF attenuates low frequencies and is used with mid-range speakers and tweeters. LPF attenuates high frequencies and is used for subwoofers. This controls channels 3 & 4.
8. **Variable Crossover 3-4** – Built in 12db crossover with frequencies between 50Hz – 250Hz.
9. **Gain Control 5-6** – This is the input sensitivity gain control for channels 5 & 6.
10. **Crossover Switch 5-6** - The HPF attenuates low frequencies and is used with mid-range speakers and tweeters. LPF attenuates high frequencies and is used for subwoofers. This controls channels 5 & 6.
11. **Variable Crossover 5-6** – Built in 12db crossover with frequencies between 50Hz – 250Hz.
12. **Power LED Indicator and Logo**

AMP DIAGRAM WITH LEGEND

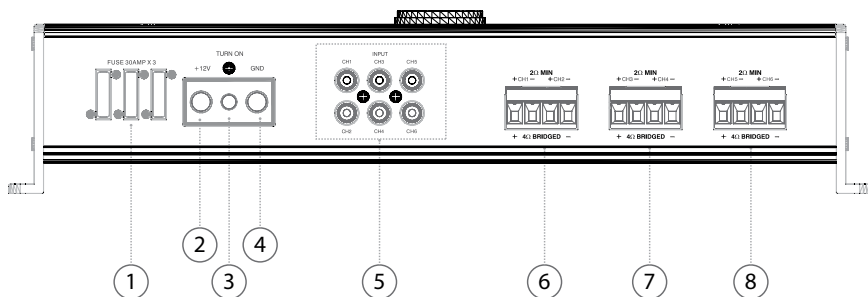

- 1. Fuses** – The fuses protect the amplifier against internal electrical damage and are meant to protect the amplifier only. All other power connections should be fused at the source
- 2. (+) 12 Volt Power** – Connect this terminal through a FUSE or CIRCUIT BREAKER to the positive terminal of the vehicle battery or the positive terminal of an isolated audio system battery.
- 3. Remote Turn On** – This terminal turns on the amplifier when (+) 12 volt is applied to it. Connect it to the Remote Turn on lead of the head unit or signal source.
- 4. Ground** – Connect this terminal directly to the battery, using the shortest wire necessary to make this connection. Always use wire of the same gauge or larger than the (+) 12 volt power wire.
- 5. RCA Inputs** - RCA Input Jacks—Accepts line level outputs from source units or signal processors at voltages between 250mV and 6 volts.
- 6. Speaker Terminal Output Block 1-2** – This is the speaker connecting block for channels 1 & 2.
- 7. Speaker Terminal Output Block 3-4** – This is the speaker connecting block for channels 3 & 4.
- 8. Speaker Terminal Output Block 5-6** – This is the speaker connecting block for channels 5 & 6.

SETTING UP THE AMPLIFIER



Input Selection

Because of the wide range of head unit/radio output configurations all Wet Sounds amplifiers have an adjustable input sensitivity or “GAIN”. The gain is NOT a volume or a power limiting control similar to a throttle. It makes the amplifier more sensitive to input from the stereo. When the gain is turned up the amplifier will reach full output at lower volume levels on the head unit/radio. Also when the gain is set too high the amplifier becomes much more sensitive to noise from your boats electrical system.

Adjusting the Gain

You will need a small flat head screwdriver and select the style/genre of music you primarily enjoy listening to.

Here are 3 easy steps to follow.

1. Turn the gain all the way counter clockwise to the “min” point on the amp.
2. Increase the head unit/radio volume to $\frac{3}{4}$ of the maximum volume output while playing your favorite style/genre of music.
3. Gently turn the gain clockwise to increase the amplifiers output until the desired level of output is achieved.

****You will repeat these steps for both the front and rear channels independently****



You should not hear any distortion in your speakers at this level, if you do, slowly turn down the gain until distortion is no longer present. If you need further assistance please contact Wet Sounds Technical Services Department.

Crossover Controls

This amplifier is designed to play frequencies between 50 Hz and 250 Hz. The amplifier is equipped 2 different optional settings. High-Pass (HI) or Low-Pass (LO), (FULL) Full-Range (See below)

“High-Pass”

designed to play only the frequencies above where the crossover is set at.

“Low Pass”

designed to play only the frequencies below where the crossover is set at.

“Full-Range”

This turns off the crossover and allows the amplifier to play every frequency.

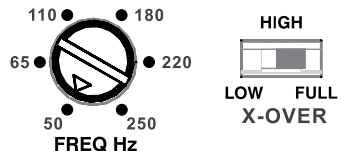

TROUBLESHOOTING



If you are experiencing problems with your amplifier after installation follow these procedures to try and remedy the problem.

1. Check your fuse and replace if necessary.
2. Confirm your Ground wire has a good connection.
3. Make sure your remote wire and power wire has +12 Volts.
4. Make sure your battery has 12 volts.
5. Confirm that the amplifier LED color is blue. If the light flashing is red than the amplifier is in protection mode. If the light is red check the following items below:
 - A. See what sequence is flashing by referencing the chart below
 - B. Confirm that a/the speaker is not blown.
 - C. Confirm that there are no loose wires that could be grounding out the amplifier.
 - D. Check that the amplifier has sufficient air circulation where it is located. Insufficient air flow and overdriving the audio system could result in the amplifier going into protection to preserve the amplifier.

Wet Sounds SYN-DX Fault Codes

	4 Seconds															
	Each division is ¼ of a Second															
Power on Operating Normally	[Blue grid]															
Power on turn on delay	[Blue grid]															
Power on Reset - First turn on	[Blue grid]															
Thermal Protection Heatsink	[Red grid]															
Thermal Protection Circuit Board	[Red grid]															
Short Protect - CH 1 or 2	[Red grid]															
Short Protect - CH 3 or 4	[Red grid]															
Short Protect - CH 5 or 6	[Red grid]															
Oversvoltage Protection 16.5V	[Red grid]															
Undersvoltage Protection 9.5V for > 20 seconds	[Red grid]															
DC Protection	[Red grid]															
DC output on any of the speakers	[Red grid]															

For HTX 4, 6 amplifiers, a short will only shut down the channels which are in fault. The other channels will continue to play. After a fault connection is cleared, the error code will continue to flash, while the logo is still illuminated blue. Please contact Tech Support for additional assistance, questions, etc.

BRIDGED AUDIO RCA CONFIGURATION

When connecting two speakers in bridged mode on channels 1-4 on the SYN-DX-4, the left and right RCA's must be split to retain stereo separation. This means you will have left audio out of the CH 1-2 and right audio out of the CH 3-4. You must also switch to **FROM CH 3-4** on the input mode section of the control panel on top of the amplifier (**example shown below**). If you choose not to configure using this method and just select **FROM CH 1-2**, then both speakers will play in mono and not stereo.

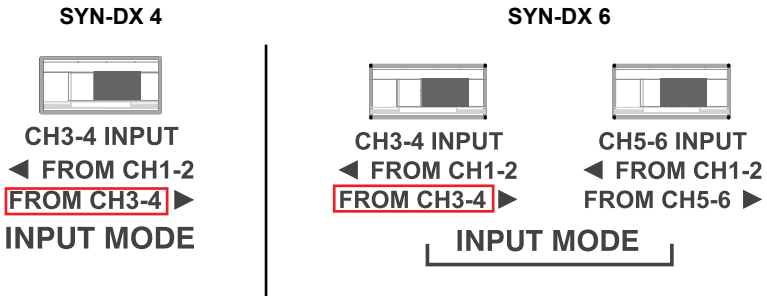

SYN-DX 4 Connection Panel

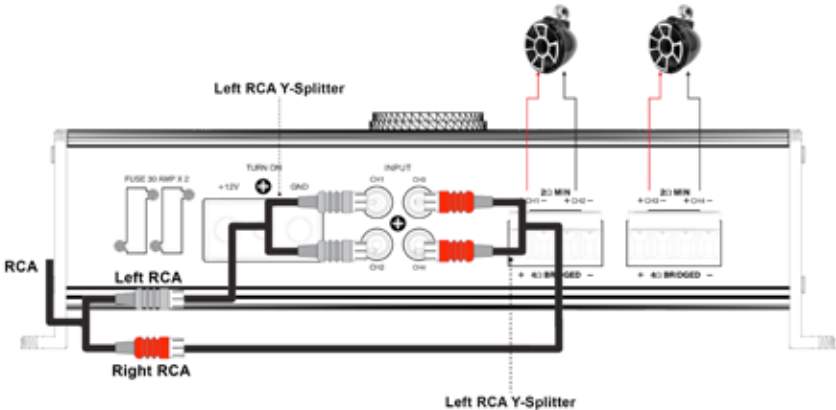

Two dual male RCA Y-Splitters are required for this configuration.

Please contact Wet Sounds Technical Support at [877.938.7757](tel:877.938.7757) if you need any assistance or how to bridge your SYN-DX Series Amplifier.

SAMPLE SYSTEM SETUPS

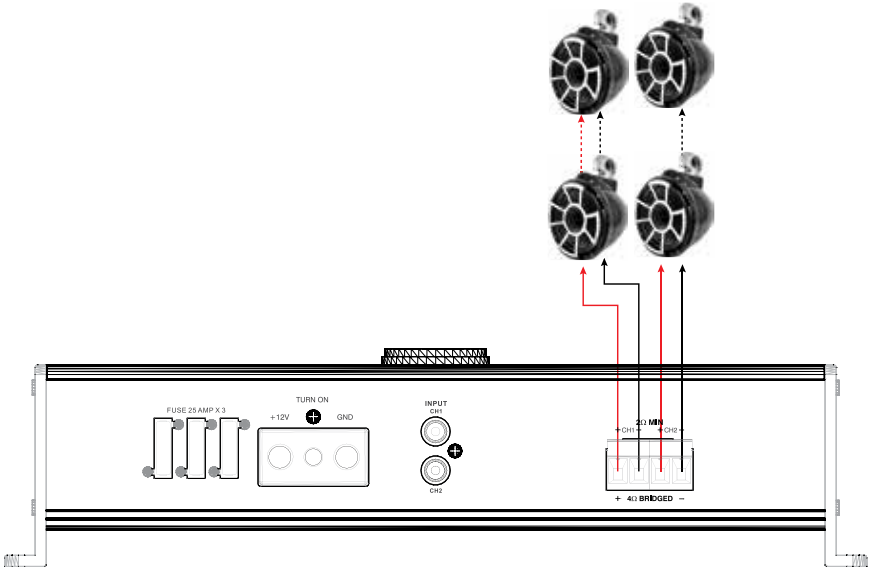

SYN-DX 2

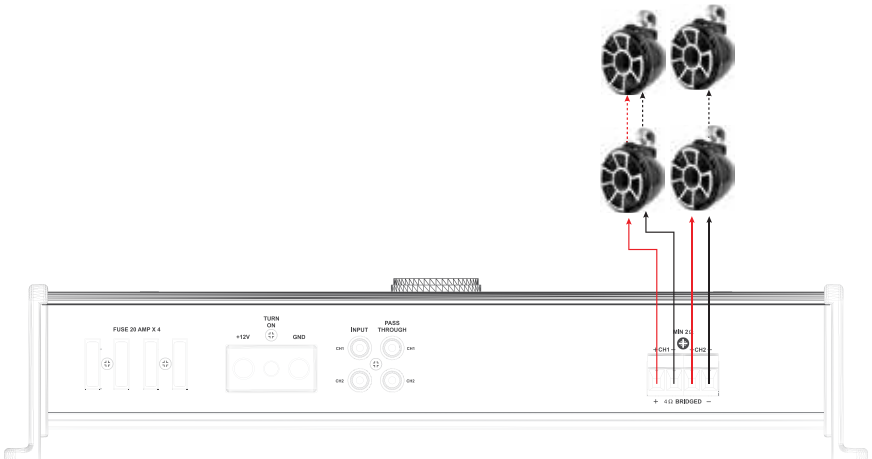

SYN-DX 2.3 HP

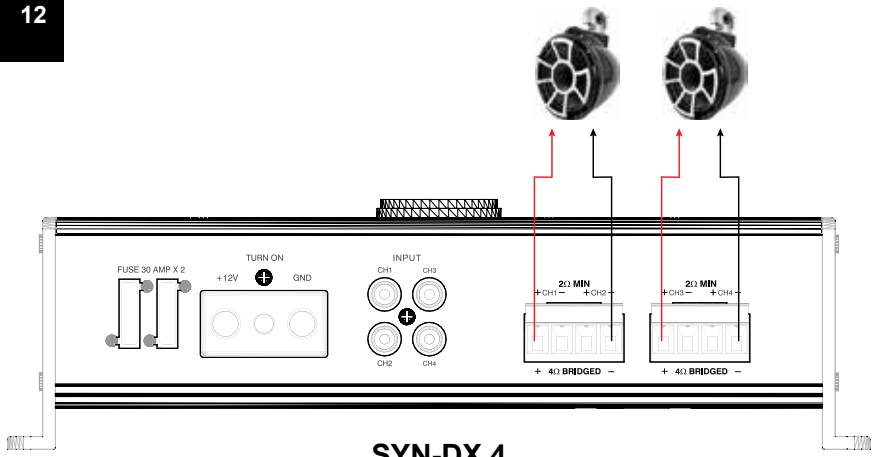

SYN-DX 4

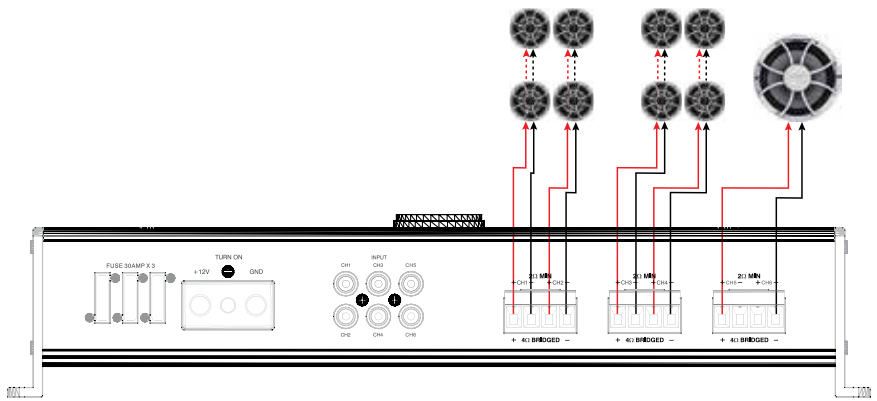

SYN-DX 6

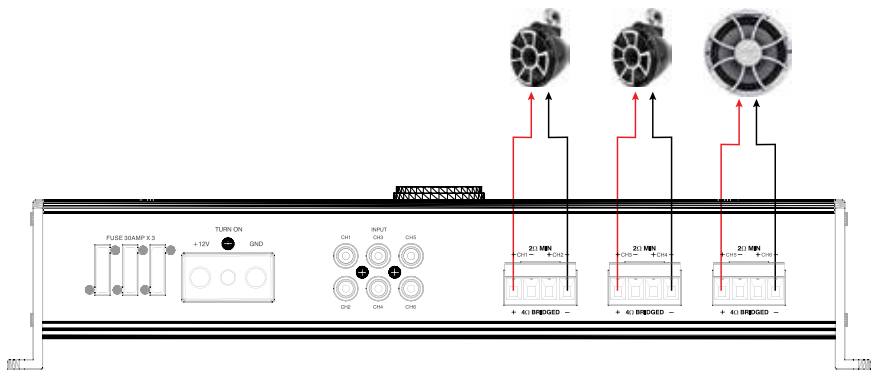

SYN-DX 6

SYN-DX 2 SPECS

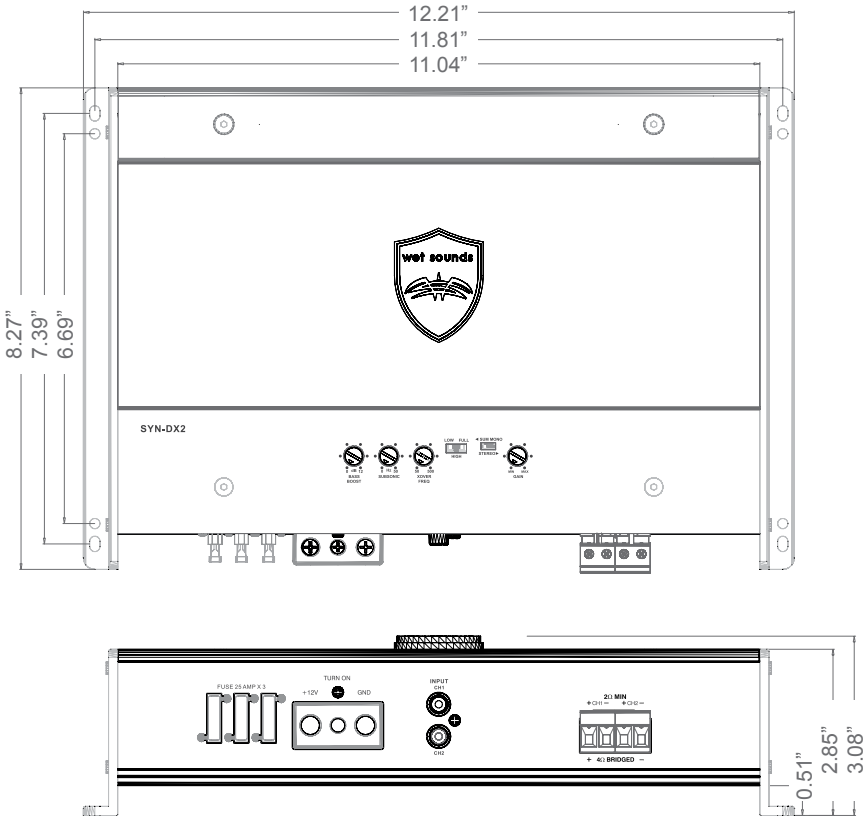

STEREO @ 4 Ohms	200W X 2 @ <1.0% THD
STEREO @ 2 Ohms	375W X 2 @ <1.0% THD
MONO @ 4 Ohms	750W X 1 @ <1.0% THD

Frequency Response	20Hz-20KHz
Crossover Range Low Pass	50Hz-250Hz 12dB/Octave
Crossover Range High Pass	50Hz-250Hz 12dB/Octave

Input Sensitivity 0.2V-6.0V

SYN-DX 2.3 HP SPECS

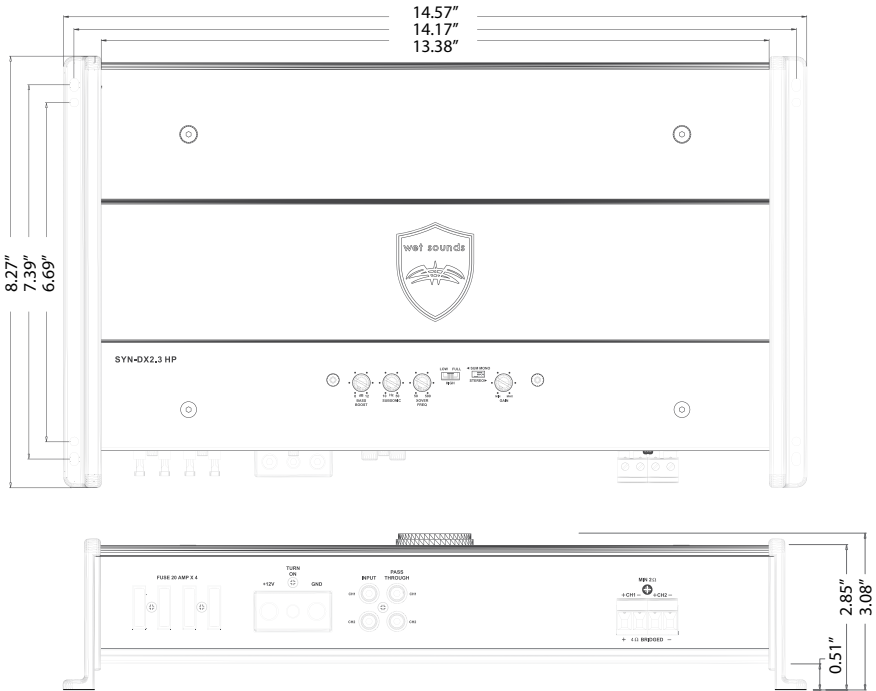

STEREO @ 4 Ohms	300 W X 2 @ <1.0% THD
STEREO @ 2 Ohms	600 W X 2 @ <1.0% THD
MONO @ 4 Ohms	1200 W X 1 @ <1.0% THD

Frequency Response	20Hz-20KHz
Crossover Range Low Pass	50Hz-500Hz 12dB/Octave
Crossover Range High Pass	50Hz-500Hz 12dB/Octave
Input Sensitivity	0.2V-6.0V

SYN-DX 4 SPECS

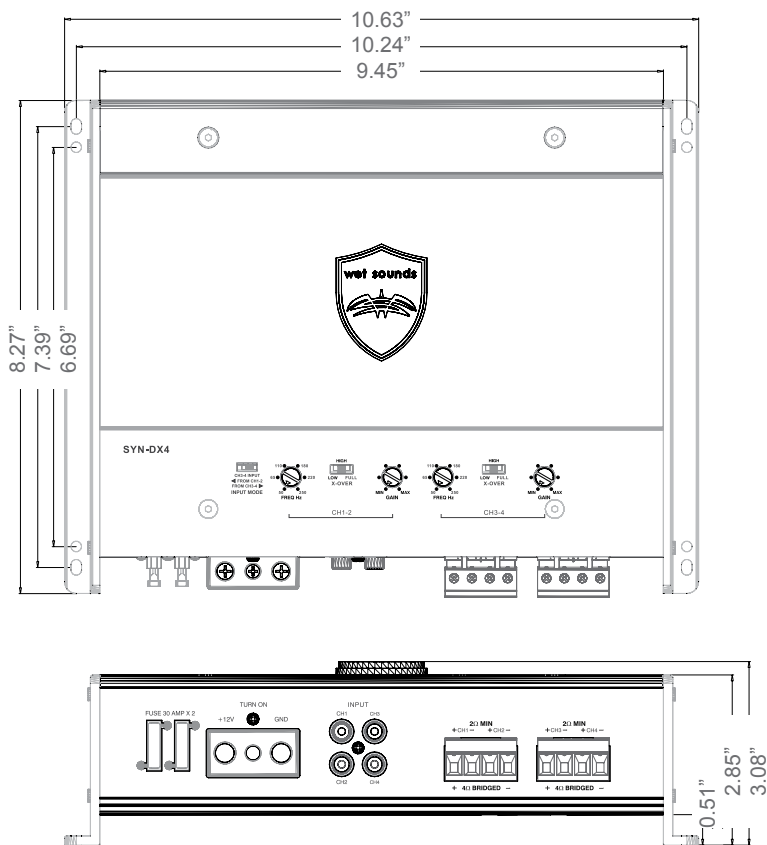

STEREO @ 4 Ohms
 STEREO @ 2 Ohms
 MONO @ 4 Ohms

125W X 4 @ <1.0% THD
 200W X 4 @ <1.0% THD
 400W X 2 @ <1.0% THD

Frequency Response

20Hz-20KHz

Crossover Range Low Pass

50Hz-250Hz 12dB/Octave

Crossover Range High Pass

50Hz-250Hz 12dB/Octave

Input Sensitivity

0.2V-6.0V

SYN-DX 6 SPECS

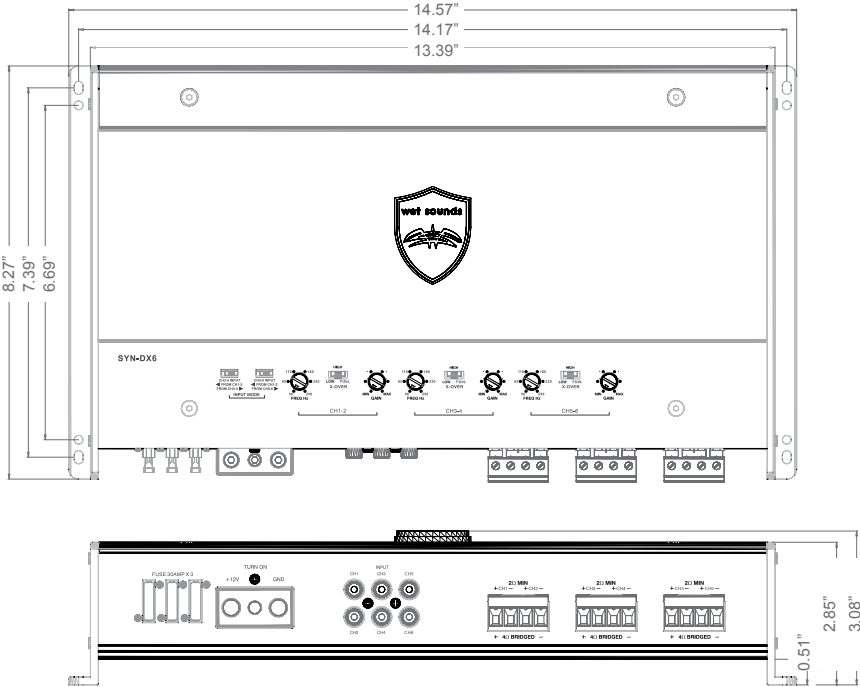

- | | |
|-----------------|-------------------------------|
| STEREO @ 4 Ohms | (CH1-4) 125 W X 4 @ <1.0% THD |
| STEREO @ 2 Ohms | (CH1-4) 200 W X 4 @ <1.0% THD |
| MONO @ 4 Ohms | (CH1-4) 400 W X 2 @ <1.0% THD |
| STEREO @ 4 Ohms | (CH5-6) 150 W X 2 @ <1.0% THD |
| STEREO @ 2 Ohms | (CH5-6) 300 W X 2 @ <1.0% THD |
| MONO @ 4 Ohms | (CH5-6) 600 W X 1 @ <1.0% THD |

- | | |
|---------------------------|------------------------|
| Frequency Response | 20Hz-20KHz |
| Crossover Range Low Pass | 50Hz-250Hz 12dB/Octave |
| Crossover Range High Pass | 50Hz-250Hz 12dB/Octave |
| Input Sensitivity | 0.2V-6.0V |

Length and limits of Warranty

Wet Sounds warrants this product to be free of defects in material or workmanship for (2) years from the date of purchase. Wet Sounds warranty applies exclusively to the original purchaser, not transferable and the amplifier must be purchased from an Authorized Wet Sounds Retailer within the United States. All products purchased outside of the United States are covered by the Authorized Distributor or OEM supplier. Any and all warranties not to exclude merchantability or fitness are limited in the duration to 2 years. This warranty gives you specific legal rights, and those rights may vary from state to state.

Items not covered

- Serial numbers that are defaced, altered or removed.
- Any product purchased outside the United States.
- Any cost related to removal, installation, shipping of the product.
- Damage caused by abuse or accident, theft, water, shipping or neglect.
- Service performed by anyone other than Wet Sounds or a Authorized Wet Sounds Service Center.
- Subsequent damage to any other components.
- Misrepresentations by the seller.
- Failure to follow installation instructions.
- Cosmetic damage.

Obtaining Service

Should service be necessary Wet Sounds (at its discretion), replace or repair the defective equipment with new or refurbished product. To receive service the original invoice of purchase with the customer name, product purchased, retailer name and address with date of purchase, must be provided to obtain warranty service. Contact Wet Sounds directly at 1-877-938-7757 contact customer service to obtain RA # (Return Authorization). You are responsible for the shipping of the product to Wet Sounds.

WET SOUNDS INC.

www.wetsounds.com

877-938-7757

10621 S Sam Houston PKWY W • Suite 100
Houston, Texas 77071
USA



PROUDLY
DESIGNED
IN THE
USA