



syn 6

1000 watt  
6 channel amplifier

OWNER'S MANUAL

## **Congratulations!**

Thank you for purchasing the Wet Sounds syn 6 amplifier. Wet Sounds professional marine audio products represent the ultimate in high performance marine audio. Wet Sounds products are specifically engineered to withstand the rigorous marine environment.

## **Warning**

We build all Wet Sounds products to play at high volumes for extended periods of time. Your ears however are not designed for high volume listening. This product can easily generate volumes that can permanently damage your hearing. We urge you to limit your exposure to very high volume sound. You may also find your state has laws governing the volume of an audio system. Please be aware of all local and state laws in your area.

A properly tuned and operated audio system will deliver years of enjoyment when used properly.

## **Installation Instructions**

Wet Sounds Marine Amplifiers are designed for easy installation in your boat. To ensure proper operation of your new purchase, please follow the suggestions we have listed below:

## **Warning**

Please check the suitability of the installation location before you begin. Do not cut any of the boat's structure. Pay close attention to what is behind the panels or carpet. Often the manufacturer will hide wires, mechanical or other electronic devices in the exact areas you wish to install in.

If you do not have experience with marine electrical and mechanical systems contact a professional installer. Paying a qualified installer is almost always cheaper than paying a dealership to repair your boat.

## **Locating the Amplifier**

The amplifiers must be securely mounted to a solid surface. Please select a dry location to mount your amplifier. All Wet Sounds products are designed to operate in humid environments however direct contact with water can damage the electronics. Do not mount the amplifier to any area that may have excess vibration (like the subwoofer box). Position the amplifier in an area that receives sufficient airflow for proper heat dissipation.

## **Supplying Enough Power**

### **The Laws of Nature**

Your amplifier Does NOT make power. It converts power, or current, from your boat's electrical system and turns it into a high power musical energy. If the amp can't get all the power it needs it will not produce its full output. Your Wet Sounds amplifier will produce Full output for longer than other amps on the market today. If the Voltage or Current drops too low even our amplifiers will drop below their rated output. Make sure your boat's charging system is in good working order. Any Hi-Performance audio amplifier will increase the demand on your alternator and battery. If you are unsure have your charging system tested by a professional technician.

## **Running the Cables**

Carefully run the power and signal cables through the passenger compartment of the boat. Always secure all wiring tightly to prevent the power wire from shorting and to reduce the risk of fire. A 4 gauge or larger wire should be used for power and ground connections. We recommend a fuse be installed on the power wire within 18 inches of the battery for safety.

## **Setting the Gains**

So you're worried that your 8 Volt output head unit will be too much for the Wet Sounds' 4 Volt input stage.

Don't Be

Wet Sounds Amplifiers input stage is rated to 4 volts RMS @ 1KHz without clipping.

Music is very dynamic. Nothing like a 1KHz test tone. It would be rare to see a peak as high as a test tone. Furthermore, your head unit produces its output at full volume but when you tune your system you always set the head unit to 70% of maximum volume.

## Input Section

Because of the wide range of head unit output configurations all Wet Sounds amplifiers have an adjustable input sensitivity or "Gain". The gain is not a volume or a power limiting control like a throttle. It makes the amp more sensitive to input from the stereo. With the gain up the amp will reach full output at a lower volume setting on the deck. At higher gain settings the amp also becomes more sensitive to noise from the boat's electrical system. Try to run the gain at the lowest setting possible for you system.

There is no correct gain setting. Because speakers require different power demands to reach the same output, the gains most often need to be used to compensate for these differences. If you tried to set all the gains at half way you would probably find the system didn't sound very good. Using good judgment and listening carefully to each speaker is still the best way to tune a system.

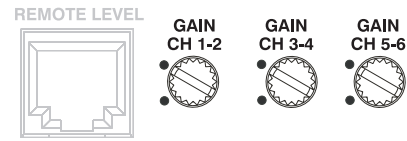

## Input Mode Switch

All Wet Sounds amplifiers include an input mode switch. This switch controls the signal being sent to the amplifier sections. Most 2 channel amplifiers can be bridged into a single channel however if the signal to the channels is not exactly the same the distortion will increase significantly. The mode switch solves this problem by offering 3 modes of operation.

### Stereo

This is simple 2 channel stereo operation. Use this setting for most applications that do not involve bridging the output.

### Bridge (CH. 2 IN)

On this amplifier Channel 2 RCA will be sent to channel 1-2 outputs. Channel 1RCA will be sent to the channel 3-4 outputs. This is a great way of get high power to a component set. These 4 channels now acts like a 2 channel amplifier that makes full power at 4 ohms.



## Crossover Controls

A crossover is a device that removes unwanted frequencies from a speaker or amplifier. A tweeter can easily be destroyed by bass notes if they are not filtered out. Likewise a subwoofer will not sound natural if it is playing midrange notes. A crossover removes these sounds from the speaker. As you might guess, careful adjustment is needed to ensure that all the speakers are playing the right sounds and that you are left with no "holes" or low spots in the frequency response.



## Bass Boost

This amp has an adjustable bass boost on channels 5-6 only. Begin your adjustments at low volume. If you do not hear any improvement then the woofer does not need any boost.

## Warning

Use Bass Boost carefully. The demands on power output are tremendous. Try to minimize the use by changing woofer position or the enclosure size.



## Speaker outputs

This amplifier is a multi channel amplifier design. Meaning it has more than one channel of speaker outputs. It is equipped with a large block style terminal for speaker connection. Make this connection carefully and neatly. Strip your wire back and twist the exposed leads and insert them into the block terminal while being careful that there is no loose or frayed strands of wire and tighten the Allen head screw down on the terminal until the wire is tightly secured in place. **DO NOT OVER TIGHTEN.** If the wires ever come in contact with each other the amplifier will go into protection.

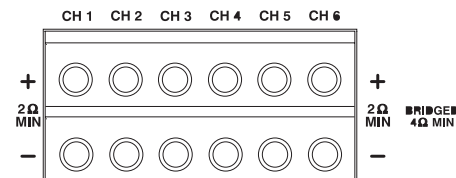

## NOTE

Know your total ohm load before you make any connections.

## Installation Instructions

1. Disconnect the negative cable from the battery. Tape up the end so it is isolated from the battery.
2. Run a 4 AWG wire from the battery positive to the amplifier. Plan this part of the installation carefully. This cable will carry very high current. If it should short to any metal or other wiring and it is not properly fused it could catch fire.
3. Connect the power wire to the battery using a fuse capable of the total current load of all amplifier connected. Don't install the fuse yet. Wait until the end. Locate the fuse as close as possible to the battery. If the fuse is further than 18 inches (wire length) from the battery you should reevaluate the wire and fuse placement.
4. Run a second 4 AWG wire from the battery negative to the amplifier. Follow the same path as the positive wire. If the negative is not done correctly system noise could occur.
5. Run the speaker wires to the speakers. It is advised that you leave some extra wire at this point. You can "clean it up" later.
6. If you haven't already done so, mount the amp now.
7. Connect the power and ground to the amplifier.

**Only after this step should you install the fuse at the battery.**

8. Connect the remote wire from the head unit to the amplifier. Now is a good time to turn on the amp for the first time. Make sure it turns on properly and does not go into protection.
9. Connect the speaker wires to the amp and speakers (make sure the amp is off first). Make sure the polarity (+ and-) is correct.
10. Connect the RCA's to the amp.
11. Double check the amplifier controls at this time. Make sure everything is set correctly for your system.
12. Now you're ready to play it for the first time. It is best to leave the gains all the way down at first. Start with the head unit volume low and work your way up.
13. Now you can tune the amp. Take your time and make only one adjustment at a time. It may take some time to get the system fully adjusted. During this time the amp is drawing current from the battery. You should check the battery voltage from time to time and re-charge it if it gets low. Battery voltage can affect the way the amplifier performs.
14. You're done. Time to head to the lake and have some fun.

## NOTE

*This amplifier is equipped with an advanced diagnostic system controlled by a microprocessor. In the event that this unit goes into protection for any reason it will flash the status light found on the control end of the amplifier. The different sequences indicate the "Code" for faster trouble shooting.*

### BLUE FLASHING

CODE 11 Red Green Flashing  
CODE 12 1 Flash, Pause, 2 Flashes  
CODE 13 1 Flash, Pause, 3 Flashes  
CODE 14 1 Flash, Pause, 4 Flashes  
CODE 15 1 Flash, Pause, 5 Flashes  
BLUE CODE 12 1 Flash, Pause, 2 Flashes

### NORMAL TURN ON

THERMAL PROTECTION (Turn the volume down and wait for the amplifier to cool)  
SHORT (Turn the amplifier off and check for a shorted speaker or wire.)  
REPEATED SHORT (Correct the short and leave the amp off for 5 minutes.)  
OVERVOLT (This is a charging system failure. DO NOT START THE ENGINE.)  
DC OFFSET (TURN OFF THE AMPLIFIER. Contact Wet Sounds for service.)  
PROCESSOR HARD RESET (Amp is OK but the processor reset do to power disconnect.)

# INPUT AND CROSSOVER CONTROLS

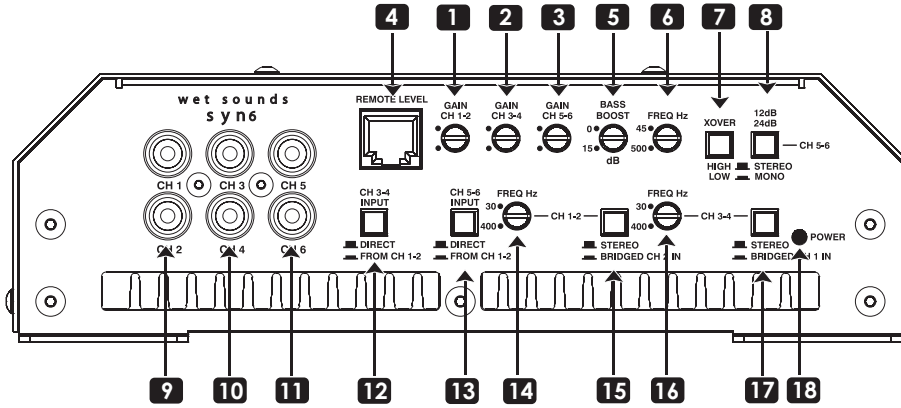

- 1** Gain Ch. 1&2
- 2** Gain Ch. 3&4
- 3** Gain Ch. 5&6
- 4** Remote Level control for Ch. 5&6
- 5** Bass Boost for Ch. 5&6
- 6** Ch. 5&6 Crossover Frequency 45Hz to 500Hz
- 7** High Pass/Low Pass Switch (in for Low Pass)
- 8** 12dB/24dB Switch 12dB Stereo 24dB Mono
- 9** Ch. 1&2 RCA Inputs
- 10** Ch. 3&4 RCA Inputs
- 11** Ch 5&6 RCA Input
- 12** Input Source Switch (in Ch. 3&4 uses Ch. 1&2 RCA)
- 13** Input Source Switch (in Ch. 5&6 uses Ch. 1&2 RCA)
- 14** Channel 1&2 Frequency 30Hz to 400Hz
- 15** Ch. 1&2 Stereo/Bridged Switch (in Ch 1&2 gets all input from Ch. 1 input)
- 16** Channel 3&4 Frequency 30Hz to 400Hz
- 17** Ch. 3&4 Stereo/Bridged Switch (in Ch. 3&4 gets all input from Ch. 2 input)
- 18** Power/Diagnostic Light

## SOURCE SELECT SWITCH OPTIONS

This amplifier is equipped with "SOURCE SELECT" switches. These work like internal "Y" connectors. It is possible to run all six channels with a single pair of RCAs. Below are the 4 possible input configurations for this amplifier.

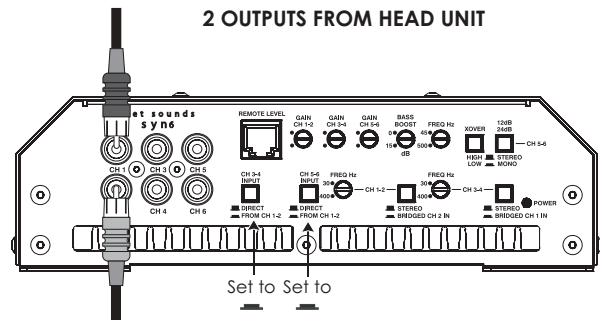
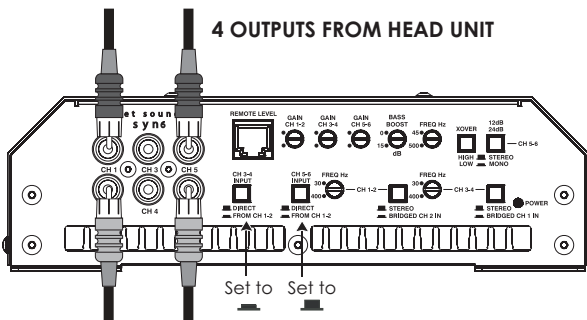
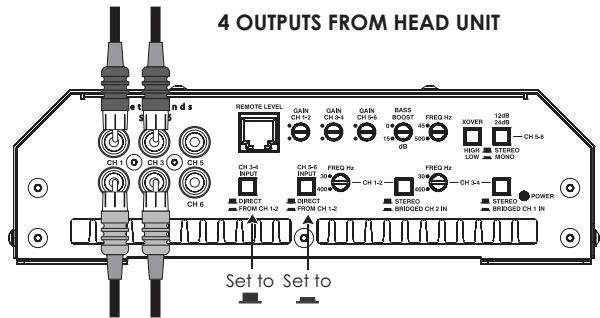
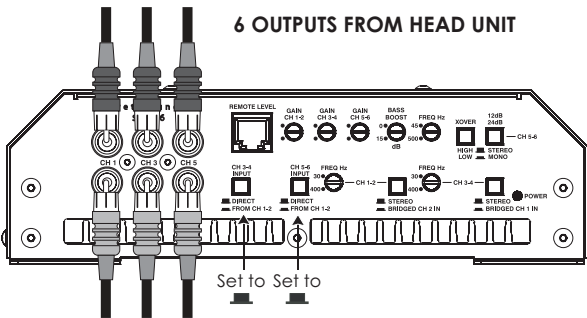

## syn 6 STEREO 4 CHANNEL WITH BRIDGED SUBWOOFERS

In this configuration channels 1-4 are used to drive interior and/or tower speakers and the Sub channels are Bridged.

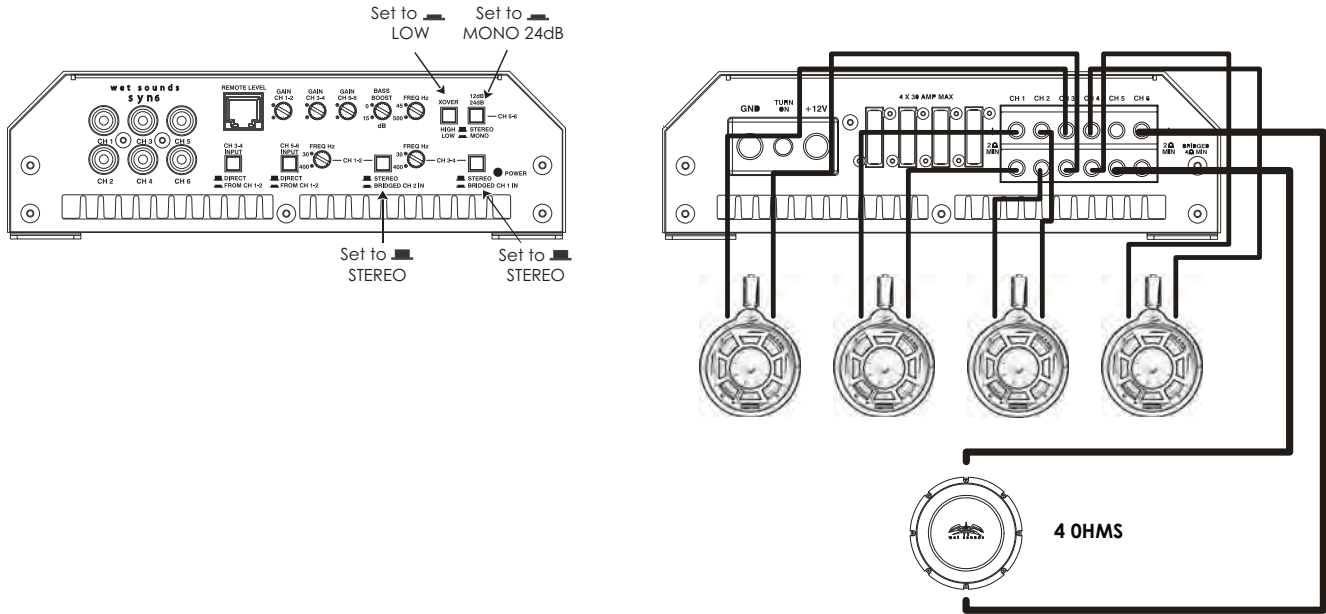

## syn 6 STEREO 6 CHANNEL

In this configuration channels 1-4 are used to drive interior speakers and channels 5/6 are running the tower speakers.

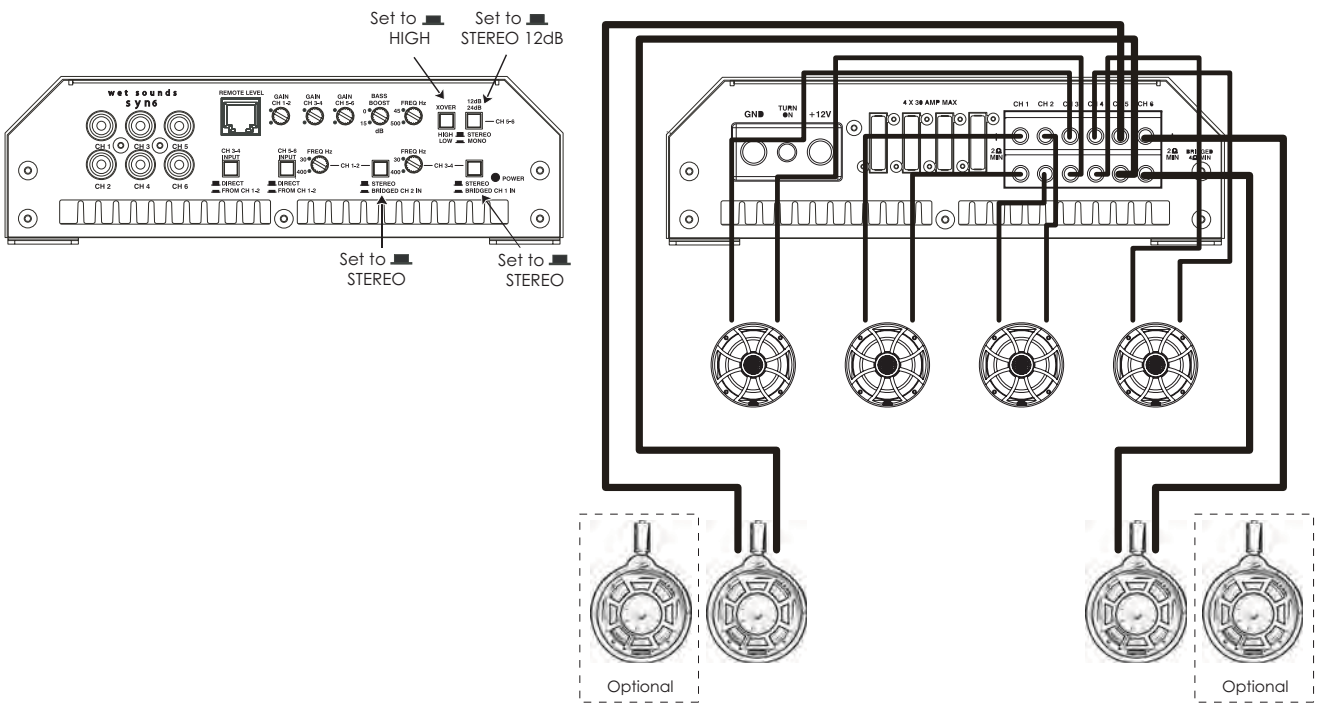

## syn 6 STEREO 6 CHANNEL HIGH PASS

In this configuration all 6 channels are used to drive interior and/or tower speakers. Channels 5&6 are bridged and set to MONO 24dB. All the crossovers are set to "HIGH".

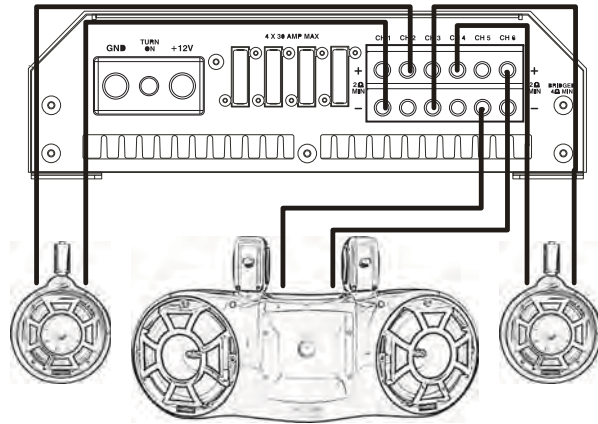
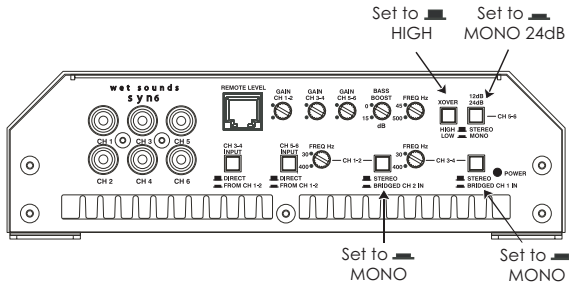

## POWER CONNECTION

Take care with all power connection. It is important to use proper fusing at all sources of electrical power. This includes Batteries, and Capacitors. Proper grounding will insure a noise free system. Make sure all grounds are clean and tight.

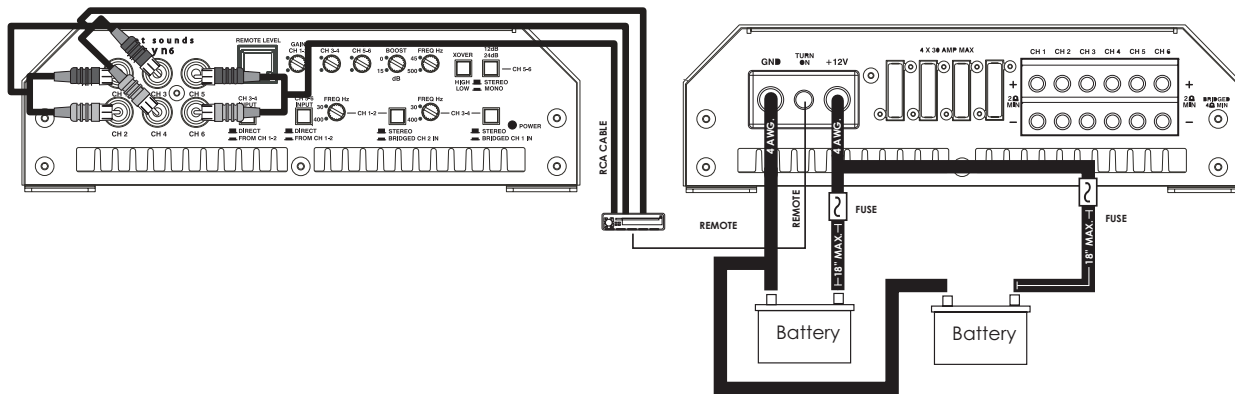

## specifications

stereo	@	4 Ohms	4 X	60	Watts
stereo	@	2 Ohms	4 X	155	Watts
mono	@	4 Ohms	2 X	305	Watts
			2 X	200	Watts
			1 X	600	Watts
s/n ratio	@	1 watt		> 77	dB
frequency response				10 Hz - 50	KHz
transient distortion				< .01%	@ 4 ohms
input sensitivity				0.6 V - 3.3	V
input impedance				20 K	ohms
bass boost				+ 15 dB @ 45	Hz
crossover Ch 1, 2, 3, 4				HP 30 Hz - 400	Hz
crossover Ch 5, 6				HP / LP 45 Hz - 500	Hz



#### What This Warranty Covers

This is a "Limited" warranty. This warranty covers any defects in materials and workmanship with your new Wet Sounds™ product. This warranty only applies to the original purchaser and is not transferable. This warranty is also only valid if the original purchase was made from an authorized Wet Sounds™ dealer.

#### How Long Coverage Last

This warranty runs for one year from the date of the purchase. \*\*\*You need to REGISTER your warranty online within 45 days of your purchase at [www.wetsounds.com](http://www.wetsounds.com) - click on "warranty registration" – to activate the full ONE YEAR warranty. If you do not register within time allotted then your warranty beyond 45 days may be Null and Void.

#### What Is Not Covered

This warranty does not cover fading or discoloration caused by use of chemicals such as ammonia, household bleach, or any cleaning material that contains abrasive substances. (For information on how to prevent fading or discoloration, consult [www.wetsounds.com](http://www.wetsounds.com) for recommendations on cleaning products) Wet Sounds, Inc. does not cover the cost for removal and reinstallation of your Wet Sounds™ product. Additionally, shipping TO Wet Sounds™, Inc. is covered by the purchaser. This warranty is void and inapplicable if Wet Sounds™ deems that the product was abused or misused; including but not limited to damage caused by accident, mishandling, improper installation, negligence, normal wear and tear, excessive water or heat damage, excessive UV exposure, freight damage or speakers that have had the drivers removed by anyone other than Wet Sounds™ technical staff. Wet Sounds™ shall not be responsible for any incidental or consequential damages, except to the extent provided (or prohibited) by applicable law.

#### What Wet Sounds™, Inc. Will Do

Wet Sounds™, Inc will repair any part of your Wet Sounds™ product that proves to be defective in materials or workmanship. In the event repair is not possible, Wet Sounds™, Inc will replace the part in question. If it is deemed necessary Wet Sounds™, Inc. will either replace the entire Wet Sounds™ product with a refurbished Wet Sounds™ product or it will be replaced with a model that is similar in price if that model is no longer available. Labor cost and materials needed to complete this service will be at no charge to the purchaser. Additionally, the cost of shipping TO the consumer is also covered under this warranty.

#### How To Get Service

Contact Wet Sounds™, Inc. either by phone at 877-938-7757 or by email at [warranty@wetsounds.com](mailto:warranty@wetsounds.com). A service representative will assist you in the necessary actions to concur that the problem that you are experiencing is covered under warranty and what to do if it needs to be shipped to Wet Sounds™, Inc.

#### How State Law Applies

This warranty gives you specific legal rights, and you may also have other rights which vary from state to state.

#### Internet Warning:

Wet Sounds, Inc. products sold on any non authorized web site or ANY internet auction site are void of any and all manufacturer's warranty. Please contact Wet Sounds™ at 877-938-7757 or visit our web site at [www.wetsounds.com](http://www.wetsounds.com) to search for an authorized site and/or an authorized retailer near you.