



w e t   s o u n d s

---

V E N U E   S E R I E S

**V E N U E   1 2 0 0**

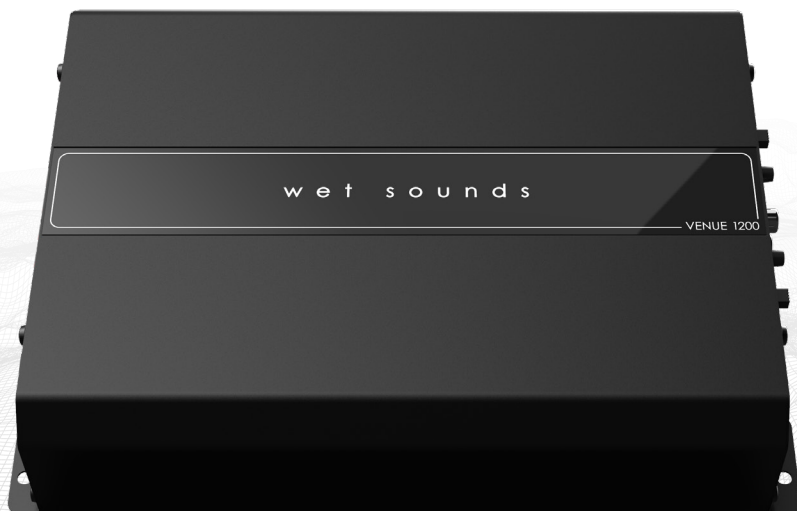

## CONGRATULATIONS!

Thank You for Your Wet Sounds VENUE SERIES Purchase.

---

Wet Sounds professional audio products represent the ultimate in high performance audio. VENUE SERIES products are specifically engineered to withstand the rigorous outdoor environment.

The Wet Sounds VENUE SERIES were designed to provide amazing output, combined with a cutting edge style. Utilizing state of the art acoustic engineering and three dimensional computer aided design, VENUE SERIES epitomize the most advanced outdoor audio products in the world.

Please take a moment to read the instruction manual before starting your installation. If you have any questions or concerns, please contact your certified Wet Sounds dealer or Wet Sounds:

877-WET-SPKR (1-877-938-7757)  
[www.wetsounds.com](http://www.wetsounds.com)

w e t   s o u n d s  

---

VENUE SERIES



# VENUE 1200

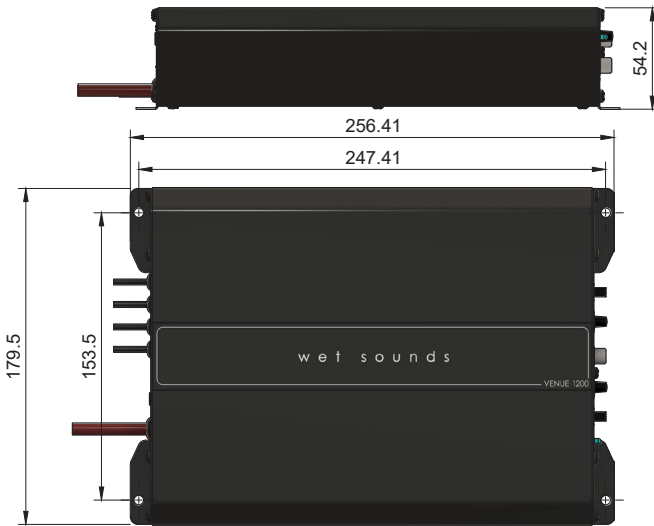

## SPECS

Power RMS @2ohm	4x312W
Power RMS @4ohm	4x200W
Frequency Response	5Hz - 20kHz
Low Pass filter	100Hz
Operating Voltage	90VAC - 240VAC
SNR	88dB
Input Sensitivity	0.2 - 2V
Current Draw (music)	5 A @110V
Current Draw (max)	18A @90V
Total Efficiency	77%
Damping Factor	200
Minimum Impedance	2ohm

## Amplifier Control Panel

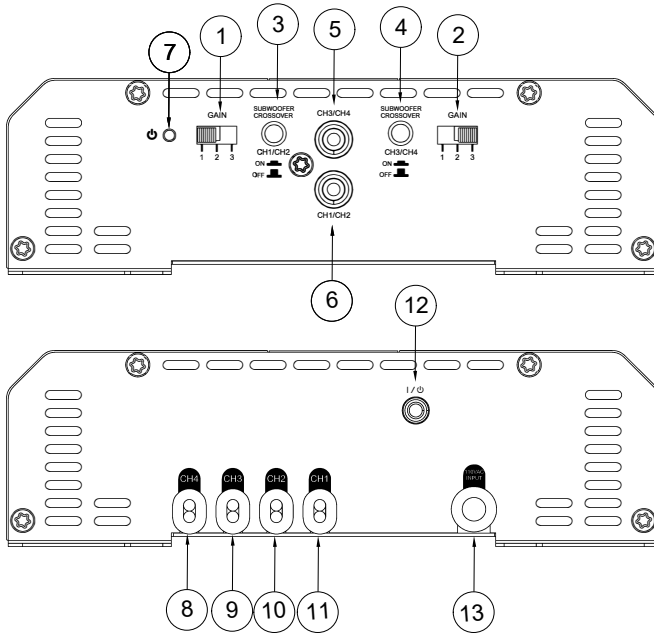

1	CH1/CH2	Selectable GAIN Control
2	CH3/CH4	Selectable GAIN Control
3	CH1/CH2	Low Pass Crossover Switch
4	CH3/CH4	Low Pass Crossover Switch
5	CH1/CH3	Audio Input - RCA Connector
6	CH2/CH4	Audio Input - RCA Connector
7	-	Power On
8	CH4	Audio Output cable
9	CH3	Audio Output cable
10	CH2	Audio Output cable
11	CH1	Audio Output cable
12	-	Power ON 12VDC Input
13	-	110VAC Input Cord



## Setup Procedure

### Gain Adjustment

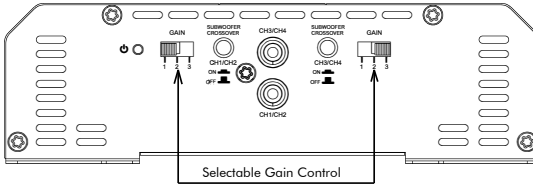

-There are two selectable gain switches, one for Ch 1/ Ch 2 and one for Ch 3 / CH 4.

Position 1	Full Range Setting
Position 2	Subwoofer Low Setting
Position 3	Subwoofer High Setting



### Crossover Adjustment

-Once the gain settings are adjusted, adjust the crossover settings accordingly. See page five details

Fullrange	Crossover Off 
Subwoofer	Crossover On 

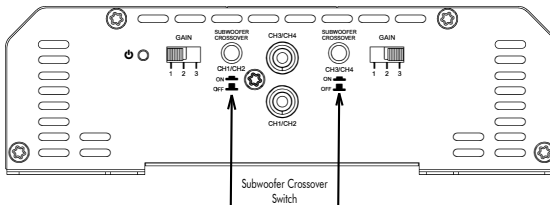

## System Layout - Full Range + Sub

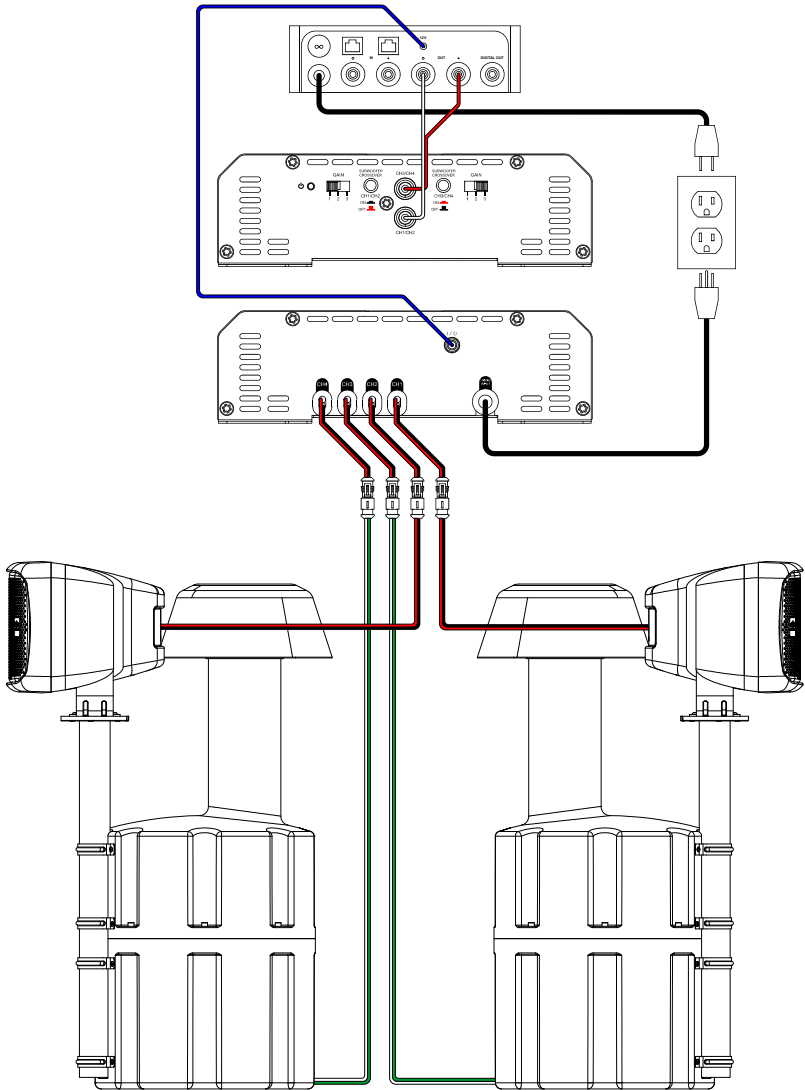

## Limited Warranty

---

### WHAT THIS WARRANTY COVERS

This is a “limited” warranty. This warranty covers any defect in materials and workmanship. This warranty only covers the original purchaser and is not transferable. This warranty is also only valid if the original purchase was made from an authorized Wet Sounds TM dealer.

### HOW LONG COVERAGE LASTS

This warranty extends for 2 years from the date of purchase. It is recommended to REGISTER your warranty online within 45 days of purchase at [www.wetsounds.com](http://www.wetsounds.com) – click on “warranty registration”.

### WHAT IS NOT COVERED

This warranty does not cover fading or discoloration caused by exposure to sunlight or chemicals such as ammonia, household bleach, or any cleaning material that contains abrasive substances. Wet Sounds, Inc. does not cover the expense for removal or re-installation. Additionally, shipping TO Wet Sounds, Inc. must be paid for by the purchaser. This warranty is void and inapplicable if Wet Sounds deems that the product was abused or misused; including but not limited to damage caused by accident, mishandling, improper installation, removing the inline fuse on the power connection, negligence, normal wear and tear, excessive water or heat damage, freight/shipping damage, or products that have been disassembled by anyone other than Wet Sounds technical staff. Wet Sounds will not be responsible for any incidental or consequential damages, except to the extent provided (or prohibited) by applicable law. This warranty gives you specific rights, and you may also have other rights which vary from state to state.

### WHAT WET SOUNDS, INC. WILL DO

Wet Sounds, Inc. will repair any part of your product that proves to be defective in materials or workmanship. In the event repair is not possible, Wet Sounds will replace the product in question. If it is deemed necessary Wet Sounds, Inc. will either replace the entire product with a refurbished unit or it will be replaced with a model that is similar in price if that model is no longer available. Labor costs and materials needed to complete this service will be at No Charge to the purchaser. Additionally, return shipping FROM Wet Sounds, Inc. to the purchaser will be paid for by Wet Sounds.

## How to get service

Contact Wet Sounds, Inc. either by phone(877-938-7757) or by email ([warranty@wetsounds.com](mailto:warranty@wetsounds.com)).

A service representative will assist you in confirming that the problem you are experiencing is caused by a defective product and if that product is covered under warranty. The service representative will issue you a Return Manufacturer's Authorization (RMA) and other details to obtain service for your product.

DO NOT RETURN YOUR PRODUCT WITHOUT THE PROPER RETURN AUTHORIZATION (RMA)!

### INTERNET WARNING

Wet Sounds, Inc. products sold on any non-authorized web site or internet auction site are void of any and all manufacturer's warranty. Please contact Wet Sounds (877-938-7757) or visit our website

([www.wetsounds.com](http://www.wetsounds.com)) for a list of authorized online sellers or to find an authorized installing retailer near you.



[www.wetsounds.com](http://www.wetsounds.com)

877-938-7757

10621 S Sam Houston PKWY W • Suite 100

Houston, Texas 77071

USA



PROUDLY  
DESIGNED  
IN THE  
USA

**Page intentionally left blank**

w e t   s o u n d s

---

V E N U E   S E R I E S



w e t   s o u n d s

[www.wetsounds.com](http://www.wetsounds.com)

877-938-7757

10621 S Sam Houston PKWY W • Suite 100

Houston, Texas 77071

USA